

OWNER' S MANUAL

WIRE CONTROLLER OF AIR CONDITIONER

MODEL: KJR-10B/DP(T)-E(F)

Thank you very much for purchasing our product.
Before using your unit, please read this manual carefully and keep it for future reference.

- This manual gives detailed description of the precautions that should be brought to your attention during operation.
- In order to ensure correct service of the wired controller please read this manual carefully before using the unit.
- For convenience of future reference, keep this manual after reading it.



CONTENTS

1. SAFETY PRECAUTION.....	1
2. WIRE CONTROLLER SUMMARIZE.....	2
3. FUNCTION SUMMARIZE.....	2
4. NAME AND FUNCTIONS OF LCD ON THE WIRE CONTROLLER.....	3
5. INSTALLATION METHOD.....	4
6. NAME AND FUNCTIONS OF BUTTONS ON WIRE CONTROLLER.....	5
7. THE USING OF WIRE CONTROLLER.....	8
AUTOMATIC OPERATION.....	8
DEHUMIDIFY OPERATION.....	8
TIMER SETTING.....	9
ONLY SET THE TIME OF TIMER ON	9
ONLY SET THE TIME OF TIMER OFF	9
SET THE TIME OF TIMER ON AND TIMER OFF SIMULTANEOUSLY ..	10
8. TECHNIQUE CERTIFICATION AND REQUIREMENT.....	10

1. SAFETY PRECAUTIONS



The following contents are stated on the product and the operation manual, including usage, precautions against personal harm and property loss, and the methods of using the product correctly and safely. After fully understanding the following contents (identifiers and icons), read the text body and observe the following rules.

■ Identifier description

Identifier	Meaning
 Warning	Means improper handling may lead to personal death or severe injury.
 Caution	Means improper handling may lead to personal injury or property loss.

[Note]: 1. "Harm" means injury, burn and electric shock which need long-term treatment but need no hospitalization
2. "Property loss" means loss of properties and materials.

■ Icon description

Icon	Meaning
	It indicates forbidding. The forbidden subject-matter is indicated in the icon or by images or characters aside.
	It indicates compulsory implementation. The compulsory subject-matter is indicated in the icon or by images or characters aside.

Warning

 Warning	Delegate installation	Please entrust the distributor or professionals to install the unit. The installers must have the relevant know-how. Improper installation performed by the user without permission may cause fire, electric shock, personal injury or water leakage.
--	-----------------------	---

 Usage Warning	Forbid	Do not spray flammable aerosol to the wire controller directly. Otherwise, fire may occur.
	Forbid	Do not operate with wet hands or let water enter the wire controller. Otherwise, electric shock may occur.

2. WIRE CONTROLLER SUMMARIZE

The basic operation conditions of wire controller are as follows:

1. The range of power supply voltage: the voltage input is 5V DC.
2. Ambient temperature range: $-15^{\circ}\text{C}\sim+43^{\circ}\text{C}$ ($-59^{\circ}\text{F}\sim+109^{\circ}\text{F}$)
3. Ambient humidity range: RH40%~RH90%.

3. FUNCTION SUMMARIZE

The wire controller has functions as follows:

1. Connect with indoor units with five terminals of A,B,C,D,E.
2. Set the mode through buttons.
3. LCD display.
4. Display the timer function of remain time

4. NAME AND FUNCTION OF LCD ON THE WIRE CONTROLLER

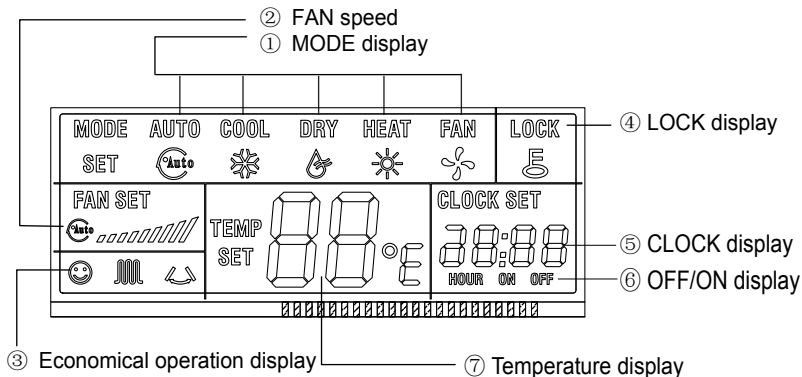

① Mode select button (MODE):
Press MODE button to select "COOL", "DRY", "HEAT", or "FAN" mode.
(HEAT is invalid for COOL ONLY wire controller.)

② Fan speed button (FAN SPEED)
Press FAN SPEED to select fan speed from "AUTO", "LOW", "MED", and "HIGH".

NOTE: some air conditioners have no

MED fan speed, then the MED is regarded as HIGH.

③ Economical operation display:
Press ECONOMICAL to display economical operation, if press ECONOMICAL again then the display disappears

④ Lock display
Press LOCK to display the icon of LOCK. Press the button again then the icon of LOCK disappears. In the mode of

LOCK, all the buttons are invalid except for LOCK button.

⑤ CLOCK display

Usually display the clock set currently. Press the button CLOCK for 4 seconds, the HOUR part will flash, press button and to adjust HOUR. Press the button CLOCK again, the minute part flash, press button or to adjust MINUTE. After clock set or clock operation, it must press CONFIRM to complete the set.

⑥ TIMER ON/OFF display:

Display ON at the state of TIMER ON adjustment or after only set the TIMER ON; Display OFF at the state of TIMER OFF adjustment or after only set the TIMER OFF; Display ON/OFF if simultaneously set the mode of TIMER ON and TIMER OFF.

⑦ Temperature display area:

Usually display the set temperature. Press the buttons of and to set temperature, at the mode of FAN, there is no figure display in the area.

5. INSTALLATION METHOD

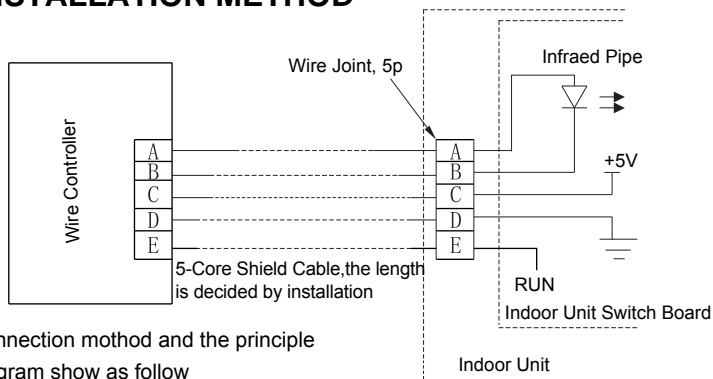

Connection method and the principle diagram show as follow

Installation interpretation:

When the air conditioner needs installing the wire controller, an additional 5-terminal is needed to install in indoor unit, fasten a infrared emission (fasten with glue), connect the anode and the cathode respectively to A and B on the end, then connect the +5V GND and RUN respectively to C D and E on the end

6. NAME AND FUNCTIONS OF BUTTONS ON WIRE CONTROLLER

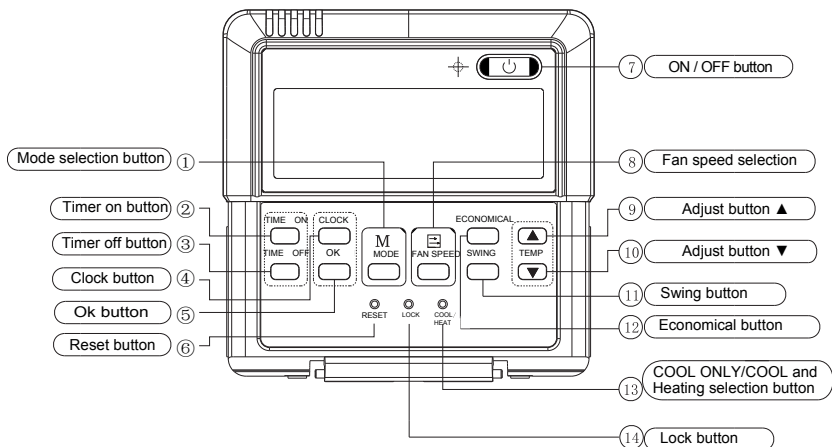

① Mode selection button:

It is used to select mode, push the button one time, then the operation modes will change in turn as follows:

AUTO→COOLING→DEHUMIDIFY→HEATING→FAN

Remarks: no heating mode if wire controller is set as the cool only.

② Timer on button :

Push the button to set TIMER ON, each time you push the button the time moves forward by 0.5 hours. When the set time is over 10 hours, each time you push the button the time moves forward by 1 hour. If want to cancel the TIMER ON, then adjust the time of TIMER ON as 0.0.

③ Timer off button:

Push the button to set TIMER OFF, each time you push the button the time moves forward by 0.5 hours. When the set time is over 10 hours, each time you push the button the time moves forward by 1 hour. If want to cancel the TIMER OFF, then adjust the time of TIMER OFF as 0.0.

④ CLOCK button:

Normally display the clock set currently (display 12:00 for the first electrifying or resetting). When push the button for 4 seconds, the hour part on the clock display flashes every 0.5 seconds, then push button and to adjust hour; push the button CLOCK again, the minute part flashes every 0.5 seconds, then push and button to adjust minute. When set clock or alter clock setting, must push the confirm button to complete the setting.

⑤ Ok button:

The button is used at the state of CLOCK adjustment. After select the time, push the button to confirm then exit, the current clock will display

⑥ Reset button(hidden):

Use a small stick with a diameter of 1mm to push the RESET button to cancel the current settings and get into the condition of resetting.

⑦ ON/OFF button:

Push the button at the condition of OFF, the OPERATION lamp lights, and the wire controller enters into ON operation,

simultaneously sends the information of operation mode set currently, temperature, fan speed, timer etc. Push the button at the condition of ON, the OPERATION lamp extinguishes, simultaneously sends the OFF. If having set TIMER ON or TIMER OFF, the wire controller will cancel these settings before entering into OFF, close the concern indicator, and then send the OFF information.

⑧ Fan speed selection button (FAN SPEED)

Select any one fan speed from "AUTO", "LOW", "MED", and "HIGH". Each time push the button, the fan speed will change in turn as fellow.

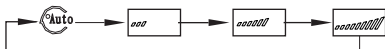

⑨ Adjust button ▲ :

Set indoor temperature up. If press and hold on, it will increase at 1 degree per 0.5 second.

⑩ Adjust button ▼ :

Set indoor temperature down . if press and hold on, it will decrease at 1 degree

per 0.5 second.

⑪ Swing button:

Push this button for the first time when operation, it will start the swing function. Push the button for the second time, cancel the swing function. (The function is available matched with the concerned unit)

⑫ Economical button:

Push the button to set the economical operation mode for air conditioner, push again then cancel the mode. The operation mode is suitable for sleeping time.

⑬ Cool only/cooling and heating selection button (hidden):

Use a small stick with a diameter of 1mm to push the button to switch modes. For COOLING ONLY type, it will be no heating mode when pressing MODE. The uniform mode is COOLING and HEATING at the factory.

⑭ Lock button (hidden):

Use a small stick with the diameter of 1mm to push the LOCK button to lock the current setting, push the button again then cancel the setting.

7. THE USING OF WIRE CONTROLLER

AUTOMATIC OPERATION

Insert the power supply, operation lamp of indoor unit flashes.

1. Push MODE to select AUTO.
2. Set the desired temperature by pushing the button and , usually the temperature range is set from 17°C (62°F) to 30°C (88°F).
3. push ON/OFF, the operation lamp of indoor unit lights, the air conditioner start operating at the AUTO mode, the fan speed is controlled automatically, wire controller display screen display "AUTO" the fan speed is un-adjustable. Push the button ON/OFF again, then the air conditioner stops operating.
4. The ECONOMICAL button is available at the AUTO operation mode.

5 .THE OPERATION OF COOL/HEAT (COOL ONLY unit hasn't the function) / FAN.

- ① Push the button MODE to select any one of "COOL", "DRY", , "HEAT", or

"FAN ONLY" mode.

- ② Select the desired temperature by pushing the button and, usually the temperature range is set from 17°C (62°F) to 30°C (88°F)
- ③ Push the button FAN SPEED to select any one of "AUTO", "LOW", "MIDDLE", or "HIGH" fan speed modes.
- ④ Push the button ON/OFF, the operation lamp on indoor unit lights, the air conditioner operates according to the mode selected. Push the button ON/OFF again, stop the air conditioner.

Remark: It can not set temperature at FAN mode, and only operate the step 1,3 and 4. The economical button is invalid at FAN mode.

DEHUMIDIFY OPERATION

1. Press MODE to select DEHUMIDIFY mode.
2. Select the desired temperature by pushing the button and, usually the temperature range is set from 17°C (62°F) to 30°C (88°F).
3. Push the button ON/OFF, the operation lamp of indoor unit lights, and the air

conditioner will start to dehumidifying. Press the button ON/OFF again, stop the air conditioner.

4.The button FAN SPEED and ECONOMICAL are invalid in the mode DEHUMIDIFY.

TIMER SETTING

1. Button TIMER ON can set the starting time.
2. Button TIMER OFF can set the stopp-ing time.

ONLY SET THE TIME OF TIMER ON

1. Push button TIMER ON, the wire controller display SETTING, the icons of HOUR and ON display on the timer setting area. The wire controller enter into the setting of timer on.
2. Push button TIMER ON again, and then adjust the time of timer on as your desired.
3. Continuously push the button, the time of timer will increase 0.5 hours per time.

After the time of timer reaches to 10 hours, the time will increase 1hour each time.

4. 0.5 seconds later, after finishing the adjustment, the wire conditioner sends the information of time on, the timer on setting is completed.

ONLY SET THE TIME OF TIMER OFF

1. Push button TIMER OFF, the wire controller display SETTING, the icons of HOUR and OFF display on the timer setting area. The wire controller enters into the setting of timer off.
2. Push button TIMER OFF again, and then adjust the time of timer off as your desired.
3. Continuously push the button, the time of timer will increase 0.5 hours per time. After the time of timer reaches to 10 hours, the time will increase 1 hour each time.
4. 0.5 seconds later, after finishing the adjustment, the wire conditioner sends

the information of timer off, the timer off setting is completed.

SET THE TIME OF TIMER ON AND TIMER OFF SIMULTANEOUSLY

1. Refer to step 1 and step 2 of TIMER ON to set the TIMER ON.
2. Refer to step 1 and step 2 of TIMER OFF to set the TIMER OFF.
3. When set the TIMER ON and TIMER OFF simultaneously, if the set times of TIMER ON and TIMER OFF are all over 10 hours, then TIMER OFF is always later 1 hour than TIMER ON.
4. 0.5 seconds later, after finishing the adjustment, the wire conditioner sends the information of timer onf, the timer off and timer on setting are completed.

Alter the timer

To alter the time of TIMER ON of TIMER OFF, push the timer button to confirm once more. Adjust the time of TIMER ON and TIMER OFF as 0.0 to cancel the TIMER ON of TIMER OFF.

Remark: the time of TIMER ON is the relative time; it is relative to the standard time of operating wire controller. If having setting the TIMER ON or TIMER OFF, then the clock can not be adjusted.

8. TECHNIQUE CERTIFICATION AND REQUIREMENT

EMC and EMR should conform to the CE certification.

Version: MDV06U-009FW

The design and specifications are subject to change without prior notice for product improvement.
Consult with the sales agency or manufacturer for details.

202055190002
2012.08.21

